

PLAN 1:20  
TRÄDGRÖP MODUL 14x14 I PREFAB-BETONG

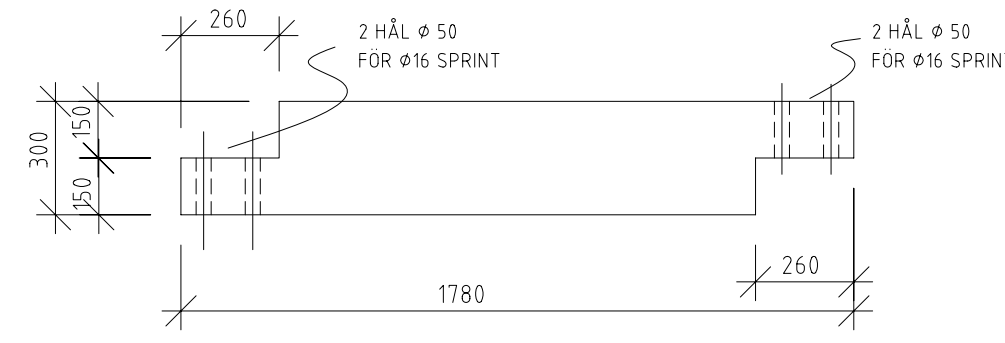

GT-1FH 1:20

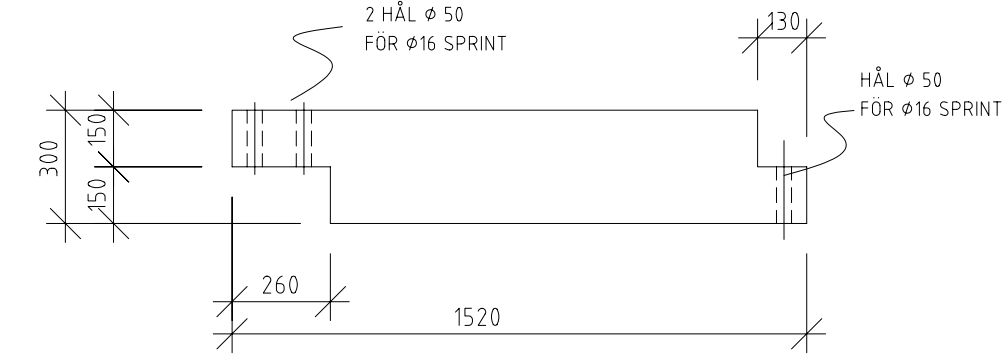

GT-2FH 1:20

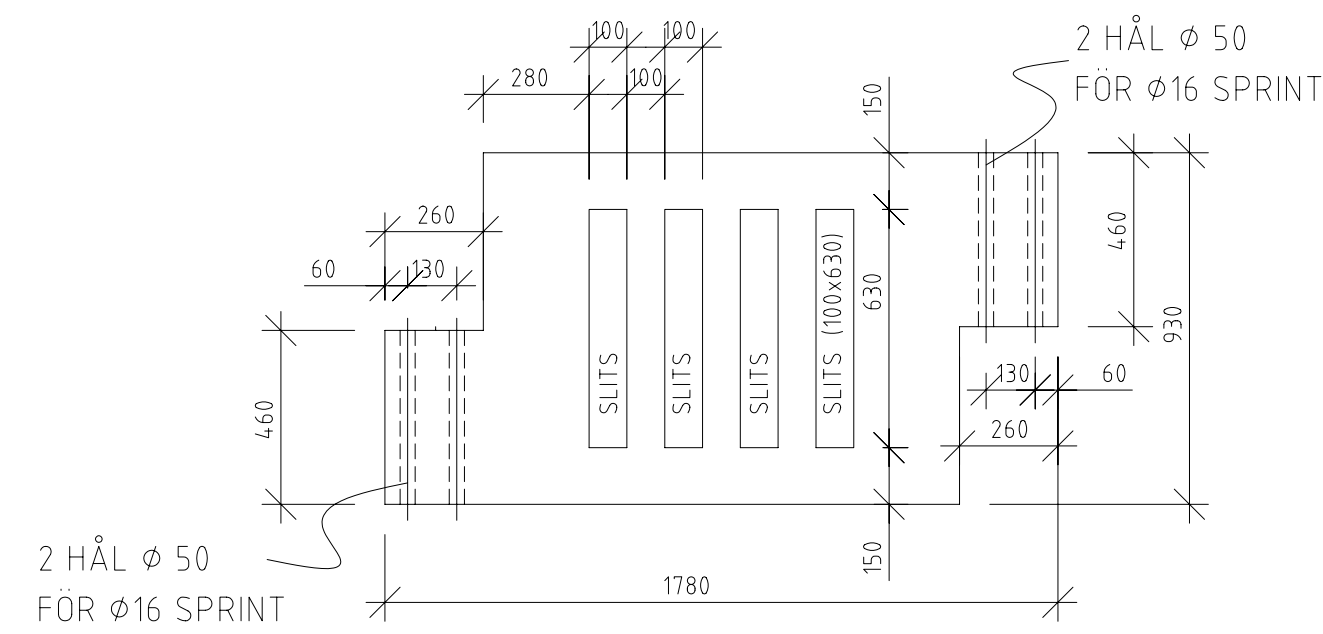

GT-1 GRUNDMODUL FÖR RAM 14x14  
fj=120 MÄTTSÄTTNING

GT-1 1:20

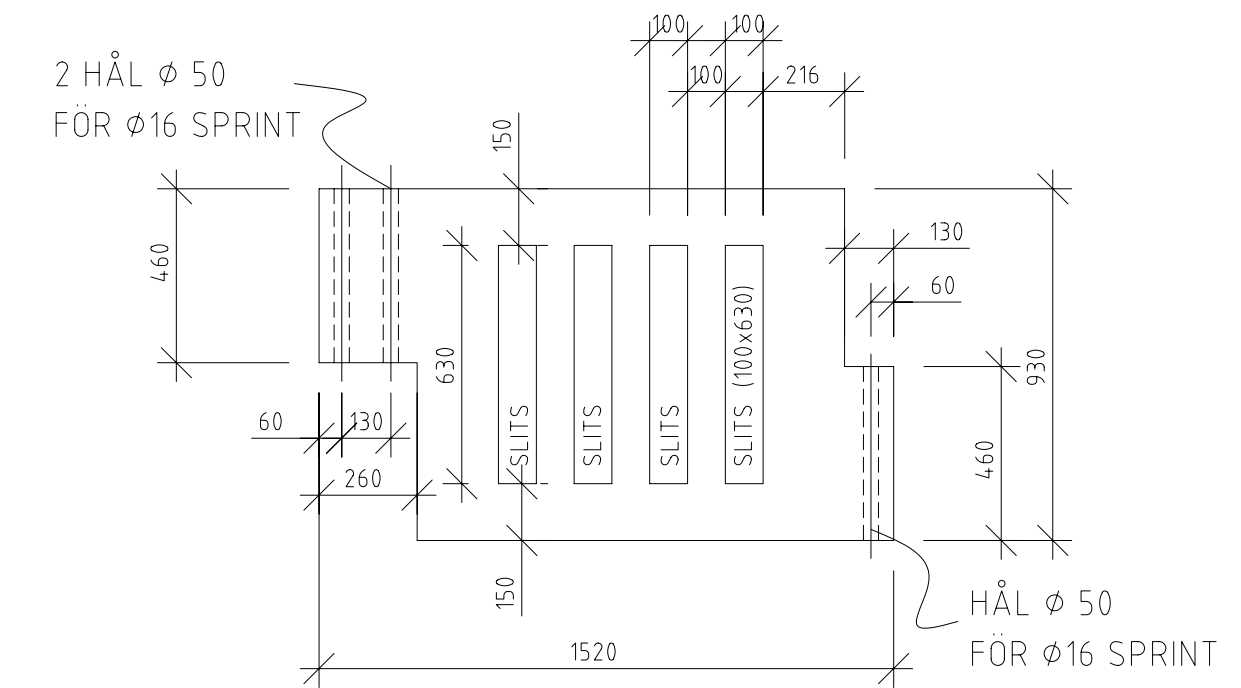

GT-2 TILLÄGGSMODUL FÖR RAM 14x14  
fj=120 MÄTTSÄTTNING

GT-2 1:20

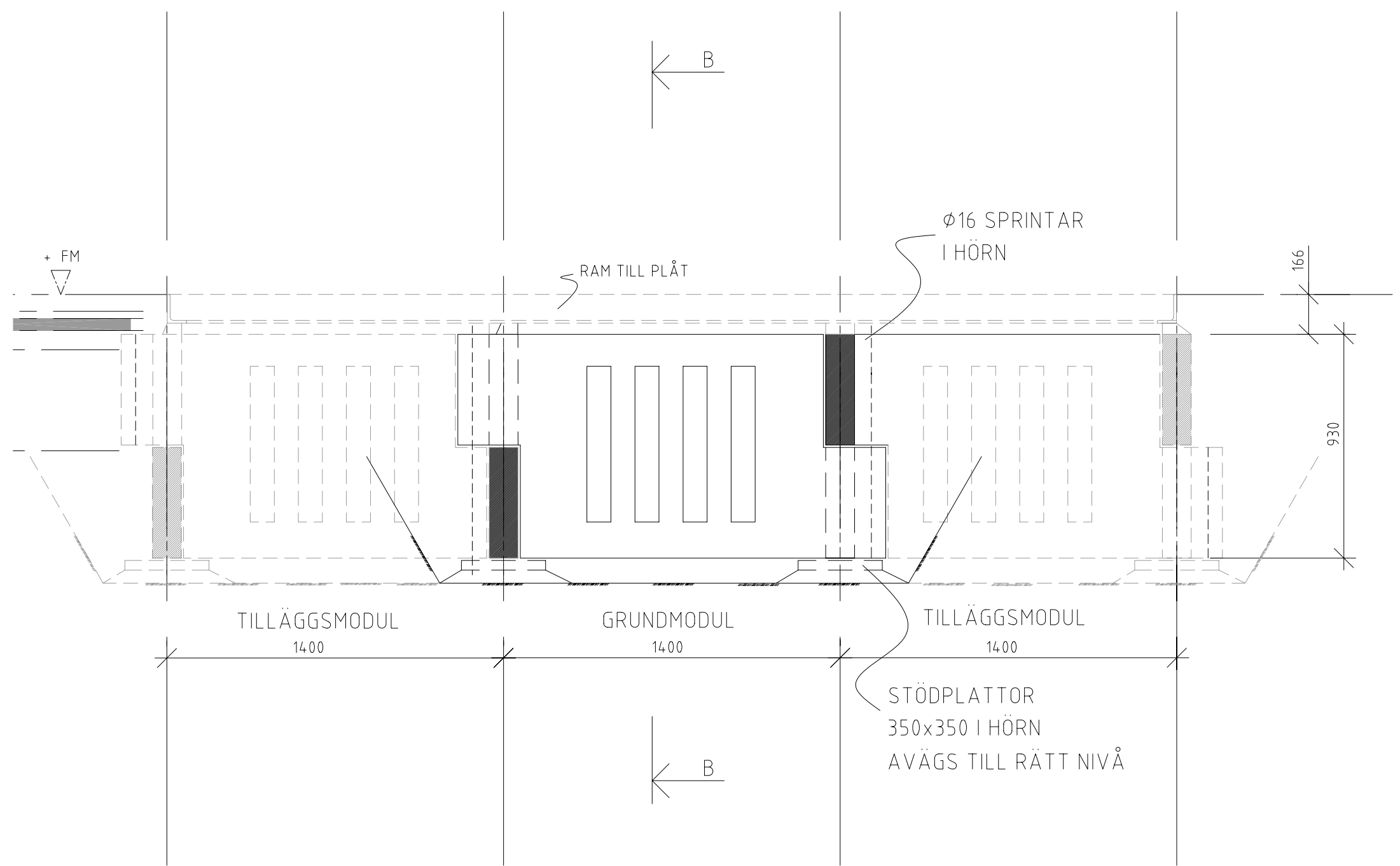

A 1:20  
ELEVATION

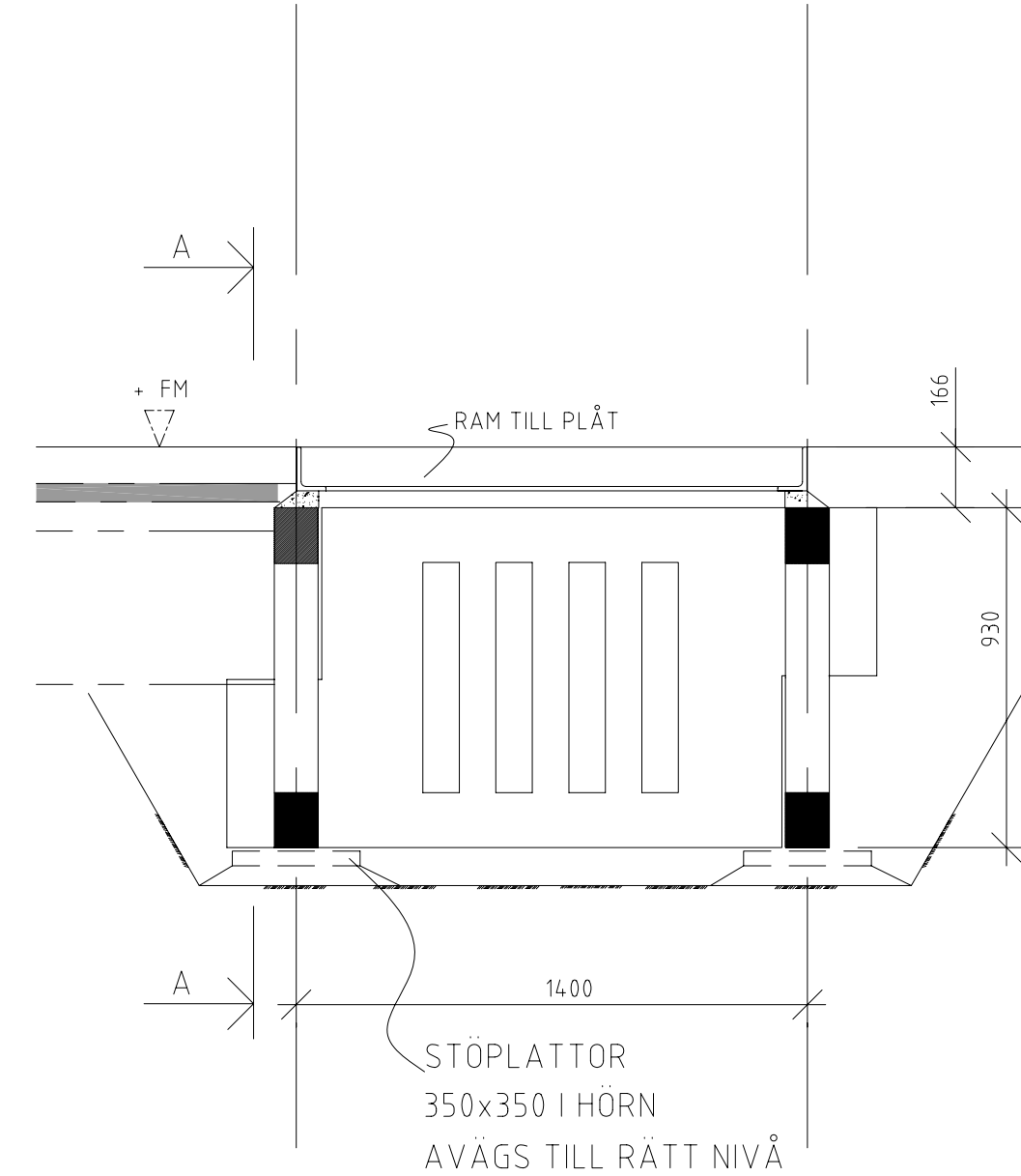

B 1:20  
GRUNDMODUL

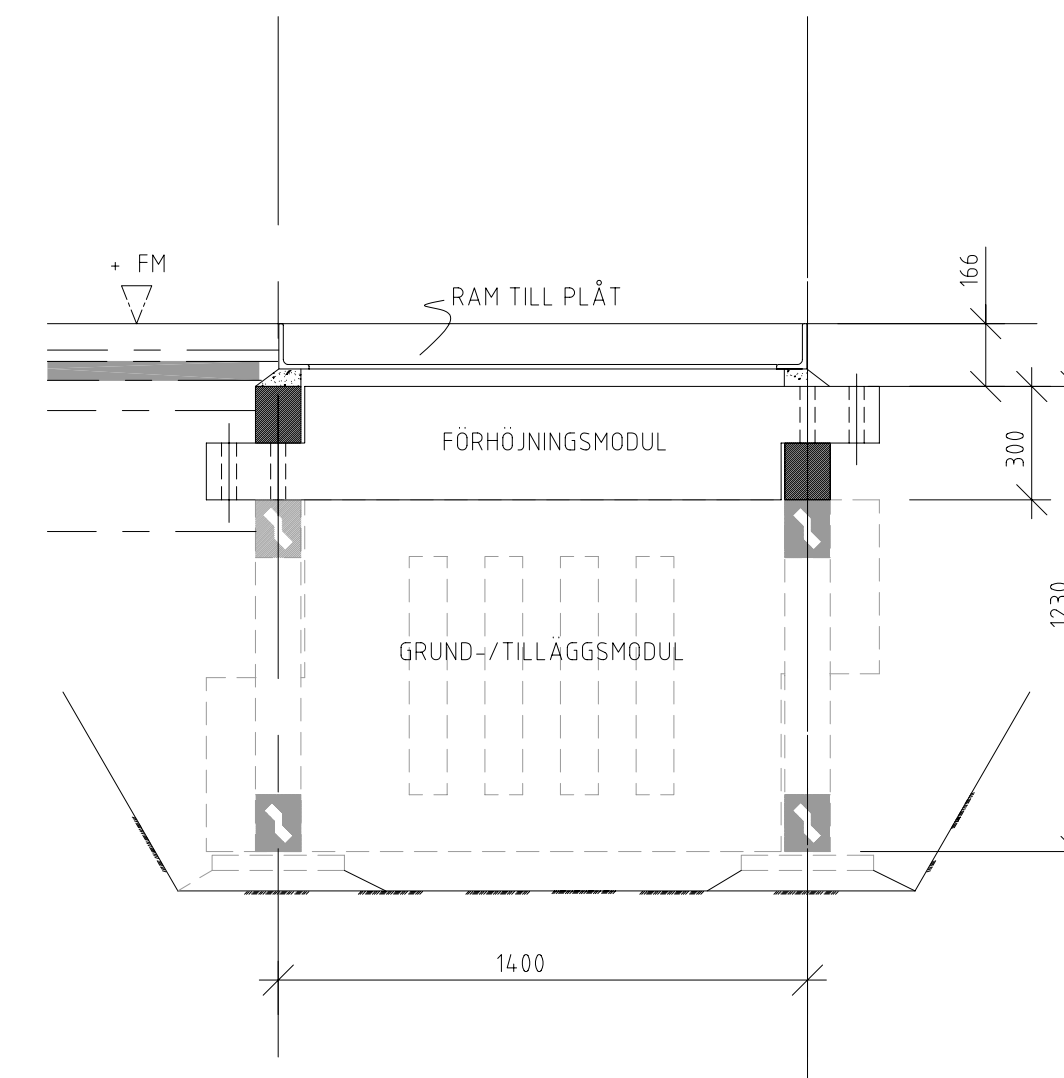

B 1:20  
PRINCIP MED FÖRHÖJNINGSMODUL